

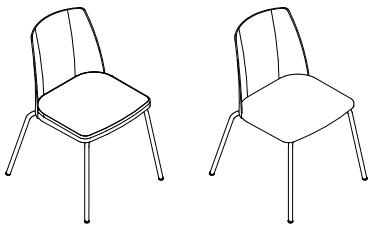

tonez 4 leg frame chair datasheet

Extent of Range

Tonez chairs with 4 leg, skid base and 5 star base with optional tilt mechanism.



Features

Type: 4 leg chair.

Back: Polypropylene curved back in a range of colours.

Seat: Polypropylene seat in a range of colours with optional 25mm thick foam seat pad upholstered in a wide range of range of fabrics.

Frame: 4 leg frame finished in RAL epoxy paint. Black glides.

Stacking: Stacks 4 freestanding and 6 on a trolley.

Product Certification

EN 16139: 2013.

Product Environmental Certification



Delivery

This range is delivered pre-assembled by the Flexiform installation team, wrapped for protection.

Environmental Manufacturing

Recycled Content: 31.75%

Recyclable Content: 100%

Product Warranty

10 years subject to our standard T&C's.

See the Flexiform Standard Warranty document for more information.

Dimensions

Overall width: 565mm
Back width: 460mm
Seat width: 440mm
Height: 785mm
Seat height: 450mm/ 475mm
Depth: 555mm
Seat depth: 430mm

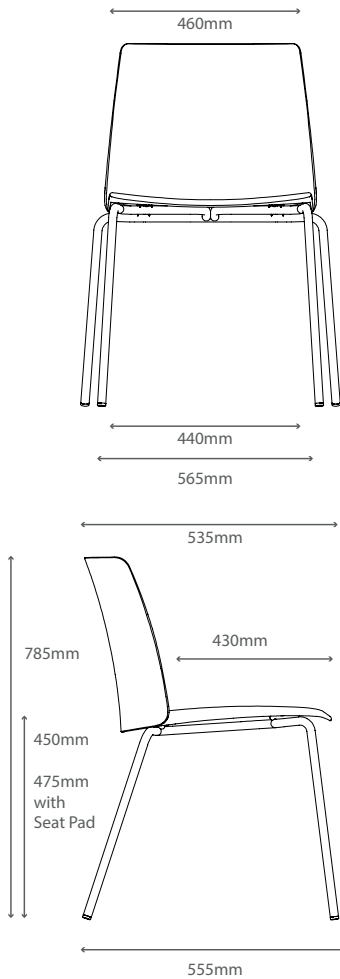

Materials

Base Material: PPGF - 100% virgin material. 100% recyclability.

Shell: PP - 100% virgin material. 100% recyclability.

Seat panel and Cap for Frame: PP - 100% recycled materials. 100% recyclability.





Glide for frame: ABS - 100 Virgin material and 100% recyclability.

Optional Fabric Seat Pad

Available in a range of fabric brands from group 1-5 and leather. Choose from Camira, Gabriel, Inloom & Agua fabrics as standard. More brands available upon request.



Base Finishes

Standard Flexiform finishes.

	Dark Painted Frame Code: D
	White Painted Frame Code: W
	Peach Pink Painted Frame Code: E
	Green Painted Frame Code: G

Plastic Finishes

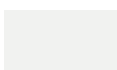
Standard Flexiform finishes.

	Dark Grey Plastic Seat & Back Code: DG
	White Plastic Seat & Back Code: WH
	Peach Pink Plastic Seat & Back Code: PP
	Green Plastic Seat & Back Code: GN