



Parq Tables and Benches
DATA SHEET

flexiform

PARQ

Parq tables and benches are available with 25mm MFC top or 50mm laminate.

Bench

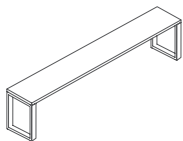

Tables

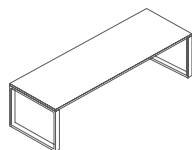
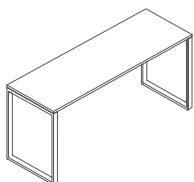

PARQ FEATURES

Type: Multi-use tables for canteen and meetings.

Legs: 50mm x 50mm square section tube, laser cut for precision. Completed with adjustable feet.

Beams: 2 central beams manufactured from 50mm x 50mm square section tube with concealed fixings.

Tops: 25mm MFC or 50mm Laminate top.

DIMENSIONS

Heights (depending upon top): 735mm/ 760mm or 1050mm/ 1075mm.

Widths: 1200mm, 1400mm, 1600mm, 1800mm, 2000mm, 2200mm or 2400mm.

Depth: 800mm.

DELIVERY

This range is assembled on site by Flexiform installation team, wrapped for protection.

WARRANTY

10 years from installation.

CERTIFICATES

BS EN 15372:2016

MATERIALS

MFC Top Panels: 25mm melamine faced chipboard (M.F.C) with 2mm ABS matching edging. British standard 476 class 1 surface spread of flame. Meets E1 European standards on Formaldehyde emissions.

Laminate: 50mm light weight MDF with high pressure laminate face balancer and 2mm ABS edging.

Steel: Powder coated steel with minimum paint coverage thickness of 35 Microns. Indentation, cross cut+adhesion and bend tested.

FINISHES

Standard Flexiform finishes. Additional colour options available (may incur an upcharge).

MFC: Light Oak (MOK), White (WHM), Beech (MOB), Maple (MOM), Grey (MOG), Walnut (MOW), Romano Cherry (RCM).

Laminate: Tobacco Aida Walnut (L01), Premium White (L02), Light Ferrara Oak (L03), Romana Cherry (L04), Ellmau Beech (L05), Light Grey (L06), Maple (L07)

Steel: RAL9006 Silver (JOS), RAL7024 Graphite (GGS), RAL7035 Pale Grey (PGS), RAL9016 White (JWS) and RAL9011 Black (BLS), Yellow Zinc RAL1018 (ZYS), Deep Orange RAL2011 (ORS), Carmine Red RAL3002 (CRS), Arrow Red RAL3001 (ARG), Pastel Mauve/ Violet RAL4009 (PMS), Tauben Blue RAL5014 (TGS), Ultramarine Blue RAL5002 (UBS), Signal Blue RAL5005 (SBS), Sky Blue RAL5015 (SBB), Regal Blue RAL5012 (RBS), Pastel Turquoise RAL6034 (PTS), Waterblue RAL5021 (WBS), Kahki Green RAL6013 (KGS), Fern Green RAL6018 (FGB).

Environmental Data

Recyclable content: 85%

ENVIRONMENTAL CERTIFICATIONS

